



VVF47..

VXF47..

ACVATIX™

## 2-port and 3-port seat valves PN16, flanged connections

VVF47..  
VXF47..

- 
- Grey cast iron EN-GJL-250
  - DN 50...150
  - $k_{vs}$  40...315 m<sup>3</sup>/h
  - Can be equipped with SBX.., SBV.. actuators

### Use

---

For use in heating, ventilating and air conditioning systems as a control valve.  
For closed circuits only.

## Type summary

Product No.	Stock No.	DN	$k_{vs}$ [m <sup>3</sup> /h]	$S_v$
VVF47.50	S55220-V106	50	40	> 50
VVF47.65	S55220-V107	65	63	
VVF47.80	S55220-V108	80	100	
VVF47.100	S55220-V109	100	160	
VVF47.125	S55220-V110	125	250	
VVF47.150	S55220-V111	150	315	
VXF47.50	S55220-V100	50	40	> 50
VXF47.65	S55220-V101	65	63	
VXF47.80	S55220-V102	80	100	
VXF47.100	S55220-V103	100	160	
VXF47.125	S55220-V104	125	250	
VXF47.150	S55220-V105	150	315	

DN = Nominal size

$k_{vs}$  = Nominal flow rate of cold water (5...30 °C) through the fully open valve ( $H_{100}$ ) by a differential pressure of 100 kPa (1 bar)

$S_v$  = Rangeability  $k_{vs}/k_{vr}$

$k_{vr}$  = Smallest  $k_v$  value, at which the flow characteristic tolerances can still be maintained, by a differential pressure of 100 kPa (1 bar)

## Ordering

### Example

Product number	Stock number	Designation	Quantity
VVF47.50	S55220-V106	2-port seat valve PN16 with flanged connection	1

### Delivery

Valves and actuators are packed and supplied separately.

The valves are supplied without counter-flanges and without flange gaskets.

### Spare parts, Rev. no.

See "Spare parts", page 11.

## Equipment combinations

Valves	Actuators			
	SBX31, SBX81, SBX61		SBV31, SBV81, SBV61	
	$\Delta p_s$	$\Delta p_{max}$	$\Delta p_s$	$\Delta p_{max}$
	kPa		kPa	
VVF47.50	300	300		
VVF47.65	175	175	400	300
VVF47.80	100	100	250	250
VVF47.100			400	300
VVF47.125			400	300
VVF47.150			400	300
VXF47.50		300		
VXF47.65		175		300
VXF47.80		100		250
VXF47.100				200
VXF47.125				100
VXF47.150				75

$\Delta p_{max}$  = Maximum permissible differential pressure across the valve, valid for the entire actuating range of the motorized valve

$\Delta p_s$  = Maximum permissible differential pressure at which the motorized valve will close securely against the pressure (close off pressure)

## Actuator overview

Type	Operating voltage	Positioning signal	Feedback signal	Positioning time (s)	Positioning force (N)	Datasheet
SBX31	AC 230 V	3-position	No	120	700	N4519
SBX81	AC 24 V	3-position	No	120	700	
SBX61	AC 24 V	DC 0...10 V	DC 0...10 V	120	700	
SBV31	AC 230 V	3-position	No	180	1600	
SBV81	AC 24 V	3-position	No	180	1600	
SBV61	AC 24 V	DC 0...10 V	DC 0...10 V	180	1600	

## Technical design / mechanical design

### Valve cross section

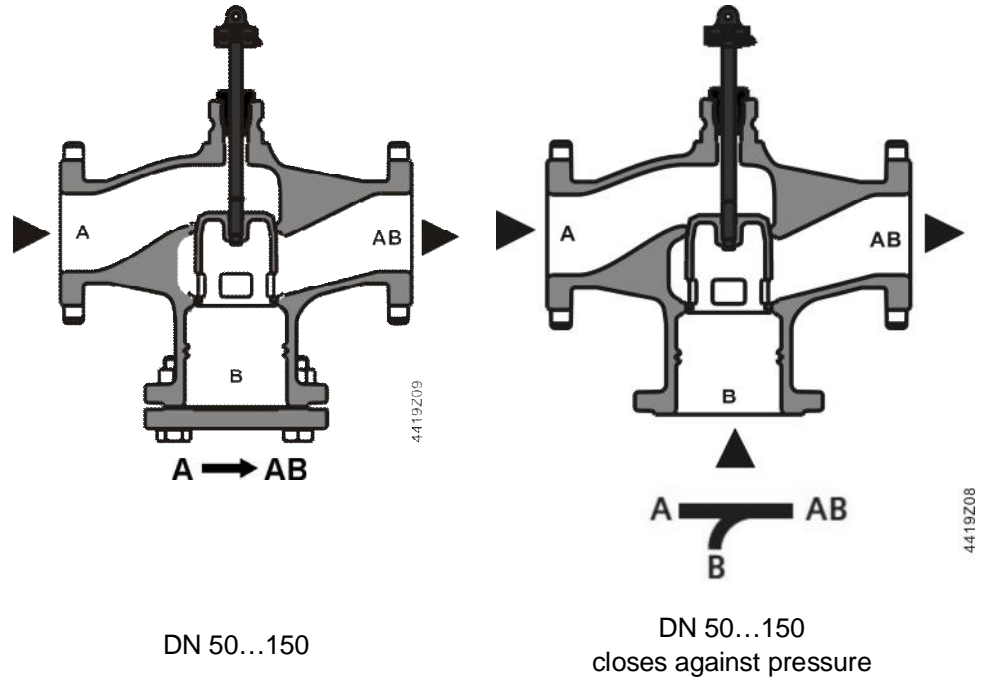

Guided plug integrated with the valve stem. The seats are machined in the valve body.

Schematic representation, design variations are possible.

The 2-port valve does not become a 3-port valve by removing the blank flange.

Sizing

Flow diagram

VVF47..

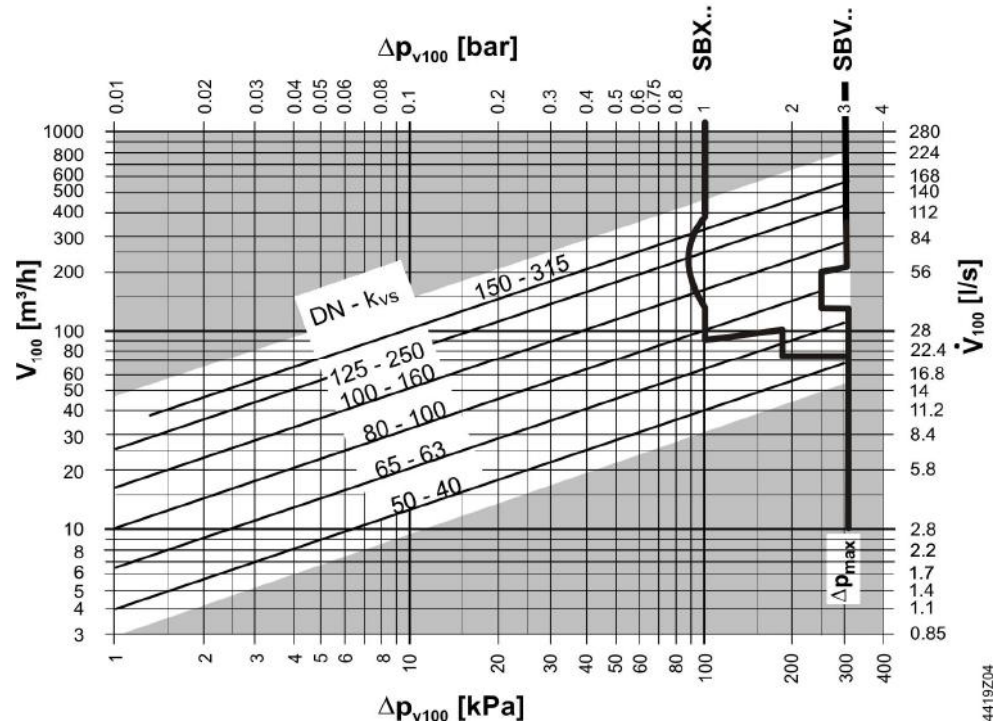

4419Z04

VXF47..

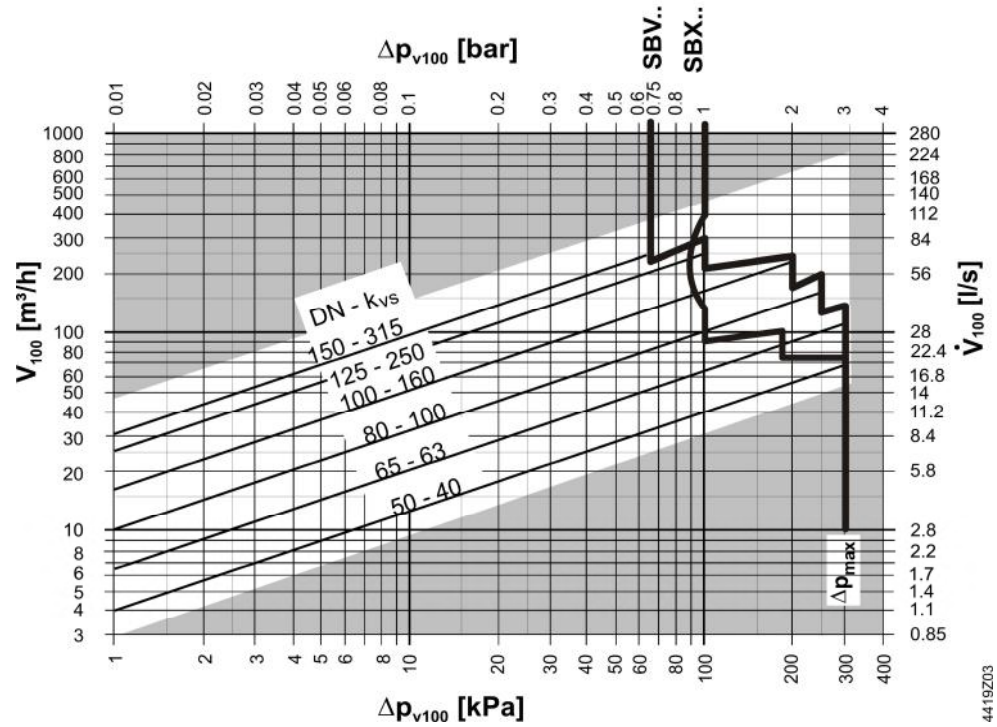

4419Z03

- $\Delta p_{max}$  = Maximum permissible differential pressure across the valve's control path, valid for the entire actuating range of the motorized valve
- $\Delta p_{V100}$  = Differential pressure across the fully open valve by a volume flow  $V_{100}$
- $V_{100}$  = Volumetric flow through the fully open valve ( $H_{100}$ )
- 100 kPa = 1 bar  $\approx$  10 mWC
- 1  $m^3/h$  = 0.278 l/s water at 20 °C

**Valve flow characteristic**  
VVF47

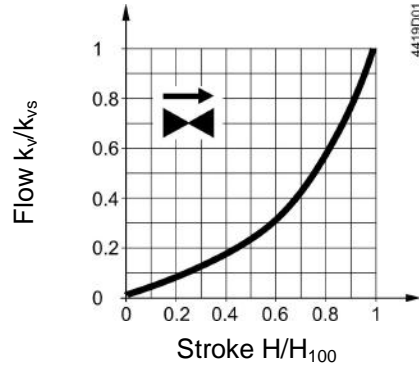

0...30%: linear  
30...100%: equal-percentage  
 $n_{gl} = 3$  as per VDI/VDE 2173

For valve  $k_{vs}$ -values 100 and 160m<sup>3</sup>/h, the characteristic is optimized for maximum volumetric flow  $k_{V100}$  at 80%...100%

VVF47.125-250  
VVF47.150-315

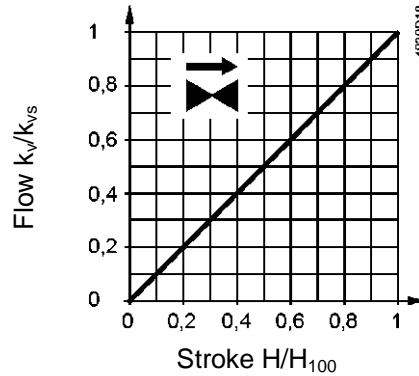

0...100%: Linear

VXF47

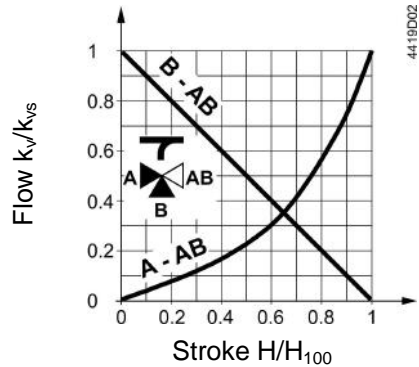

**Throughport A-AB**

0...30%: linear  
30...100%: equal-percentage  
 $n_{gl} = 3$  as per VDI/VDE 2173

For valve  $k_{vs}$ -values  $\geq 100$ m<sup>3</sup>/h, the characteristic is optimized for maximum volumetric flow  $k_{V100}$  at 80%...100%

**Bypass B-AB**

0...100%: linear

## Cavitation

Cavitation accelerates wear on the plug and seat, and also results in undesirable noise. Cavitation can be avoided by not exceeding the differential pressure shown in the flow diagram on page 4, and by adhering to the static pressures shown below.

## Note on chilled water

To avoid cavitation in chilled water circuits, please ensure sufficient counter pressure at valve outlet, e.g. by a throttling valve after the heat exchanger. Select the pressure drop across the valve at maximum according to the 80 °C curve in the flow diagram below.

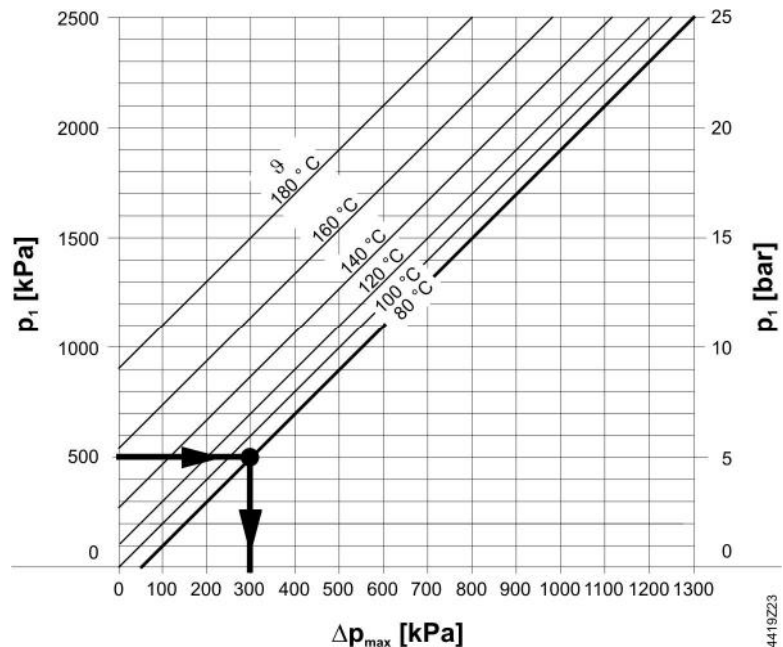

- $\Delta p_{max}$  = Differential pressure with valve almost closed, at which cavitation can largely be avoided
- $p_1$  = Static pressure at inlet
- $p_3$  = Static pressure at outlet
- M = Pump
- $\vartheta$  = Water temperature

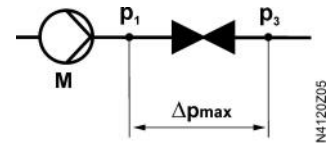

Use the 3-port valve as a mixing valve.

## Working pressure and medium temperature

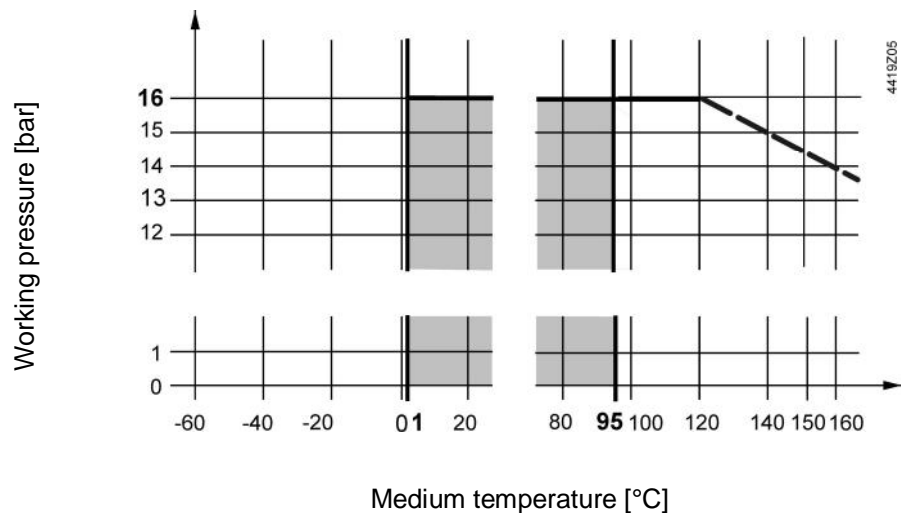

Working pressure and medium temperature are according to ISO 7005

Current local legislation must be observed.

**Notes**

**Engineering** We recommend installation in the return pipe, as the temperatures in this pipe are lower for applications in heating systems, which in turn, extends the stem sealing gland's life.

Ensure cavitation free flow, see page 6.

**Warning**  Always use a strainer upstream of the valve to increase the valve's functional safety.

**Mounting** Both valve and actuator can easily be assembled at the mounting location. Neither special tools nor adjustments are required.

The valve is supplied with Mounting Instructions 74 319 0765 0.

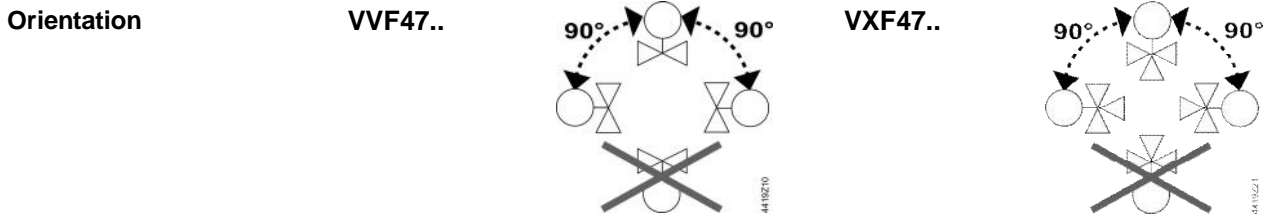

**Direction of flow** When mounting, pay attention to the valve's flow direction symbol.

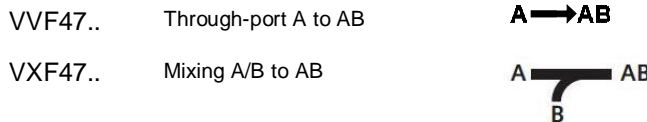

**Commissioning**  **Commission the valve only if the actuator has been mounted correctly.**

VVF47.. Valve stem retracts: valve opens = increasing volumetric flow  
 Valve stem extends: valve closes = decreasing volumetric flow

VXF47.. Valve stem retracts: through-port A – AB opens, bypass B closes  
 Valve stem extends: through-port A – AB closes, bypass B opens

## Maintenance notes

---

### Warning



V..F47.. valves require no maintenance.

When doing service work on the valve/actuator:

- Deactivate the pump and turn off the power supply
- Close the shutoff valves
- Fully reduce the pressure in the piping system and allow pipes to completely cool down

If necessary, disconnect the electrical wires.

Before putting the valve into operation again, make certain the actuator is correctly fitted.

### Stem sealing gland

The glands cannot be exchanged at job site. Contact your local office or branch if the stem sealing gland range is damaged.

### Disposal



Before disposal, the valve must be dismantled and separated into its various constituent materials.

Legislation may demand special handling of certain components, or it may be sensible from an ecological point of view.

**Current local legislation must be observed.**

### Warranty

---

The technical data given for these applications is valid only in conjunction with the Siemens actuators. For details, please see page 2 "Equipment combinations". All terms of the warranty will be invalidated by the use of actuators from other manufacturers.



## Technical data

<b>Functional data</b>	PN class	PN 16 to ISO 7268
	Working pressure	To ISO 7005 within the permissible "medium temperature" range according to the diagram on page 6.
	Flow characteristic	See section "Valve flow characteristic" on page 5.
	Leakage rate through-port bypass	0...0.1% of $K_{vs}$ value 0.5...2% of $K_{vs}$ value
	Permissible media	Chilled water, low temperature hot water, high temperature hot water, water with anti-freeze, brine; recommendation: water treatment to VDI 2035
	Medium temperature	1...95 °C
	Rangeability $S_v$	DN 50...150: > 50
	Nominal stroke	DN 50...80: 20 mm DN 100...150: 40 mm
<b>Materials</b>	Valve body	Grey cast iron EN-GJL-250
	Stem	Stainless steel
	Plug	Bronze or stainless steel
	Sealing gland	O-ring: EPDM; Wiper ring: PTFE
<b>Dimensions/Weight</b>	Refer to "Dimensions", page 10.	
	Flange connections	To ISO 7005
<b>Environment</b>	Operation	Class 3K5, 3Z11 Temperature -10...55 °C Rel. Humidity 5...95% r.h.
	Storage	Class 1K3 enhanced Temperature -15...50 °C Rel. Humidity <95% r.H.
	Transport	Class 2K3, 2M2 Temperature -30...+65 °C Rel. Humidity < 95% r.H.
<b>Norms</b>	PN class	ISO 7268
	Working pressure	ISO 7005
	Flanges	ISO 7005
	Length of flanged valves	DIN EN 558-1, Series 1
	Valve flow characteristic	VDI 2173
	Leakage rate	Throughport, bypass according to EN 60534-4 / EN 1349
	Water treatment	VDI 2035
	Environment	Storage: IEC 60721-3-1 Transport: IEC 60721-3-2 Operation: IEC 60721-3-3
	Environmental compatibility	ISO 14001 (Environment) ISO 9001 (Quality) SN 36350 (Environmentally compatible products) Directive 2002/95/EC (RoHS)

## Dimensions (mm)

VVF47..

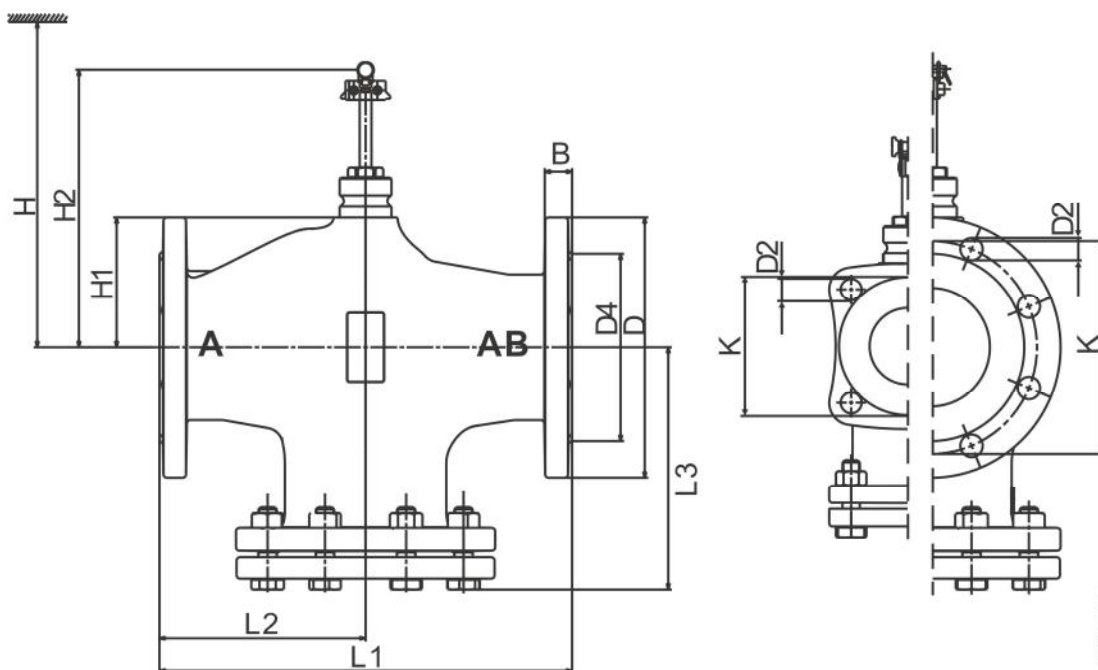

4419M06

	DN	B	Ø D	Ø D2	Ø D4	K	L1	L2	L3	H1	H2	H		Weight
												SBX..	SBV..	
							mm						kg	
VVF47.50	50	20	165	19 (4x)	99	125	230	115	143	50	155	> 410		11.0
VVF47.65	65	20	185	19 (4x)	118	145	290	145	173	75	180	> 435	>500	16.0
VVF47.80	80	22	200	19 (8x)	132	160	310	155	185	75	180	> 435	>500	23.8
VVF47.100	100	24	220	19 (8x)	156	180	350	175	205	110	235		> 530	32.5
VVF47.125	125	26	250	19 (8x)	184	210	400	200	233	123	248		> 540	45.0
VVF47.150	150	26	285	23 (8x)	211	240	480	240	275	150	275		> 670	65.0

VXF47..

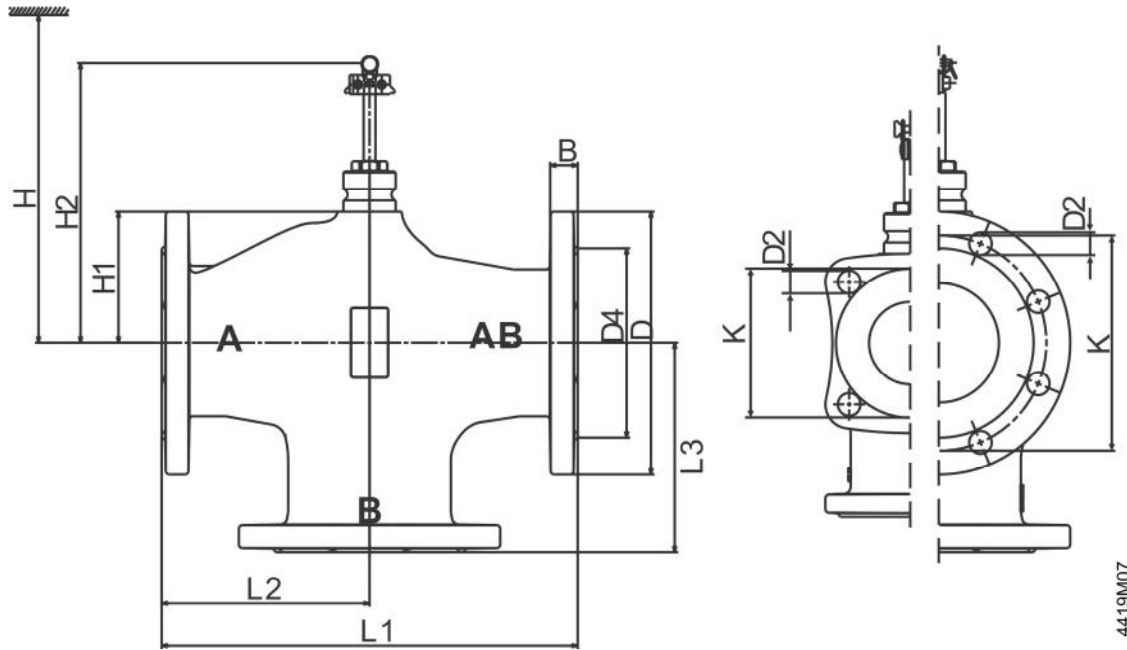

4419M07

	DN	B	Ø D	Ø D2	Ø D4	K	L1	L2	L3	H1	H2	H		Weight
												SBX..	SBV..	
mm													kg	
VXF47.50	50	20	165	19 (4x)	99	125	230	115	115	50	155	> 410		8.7
VXF47.65	65	20	185	19 (4x)	118	145	290	145	145	75	180	> 435	>500	12.9
VXF47.80	80	22	200	19 (8x)	132	160	310	155	155	75	180	> 435	>500	19.5
VXF47.100	100	24	220	19 (8x)	156	180	350	175	175	110	235		> 530	27.7
VXF47.125	125	26	250	19 (8x)	184	210	400	200	200	123	248		> 540	38.3
VXF47.150	150	26	285	23 (8x)	211	240	480	240	240	150	275		> 570	54.1

DN = Nominal size

H = Total actuator height plus minimum distance to the wall or the ceiling for mounting, connection, operation, maintenance etc.

H1 = Dimension from the pipe centre to install the actuator (upper edge)

H2 = Valve in the "Closed" position means that the stem is fully extended

Spare parts

Order numbers for spare parts

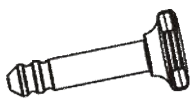
Product number	Product number	Order number	Connection pin
VVF47.50	VXF47.50	100996940	
VVF47.65	VXF47.65		
VVF47.80	VXF47.80		
VVF47.100	VXF47.100		
VVF47.125	VXF47.125		
VVF47.150	VXF47.150		

Revision number

Product number	Valid from rev. number	Product number	Valid from rev. number
VVF47.50	..A	VXF47.50	..A
VVF47.65	..A	VXF47.65	..A
VVF47.80	..A	VXF47.80	..A
VVF47.100	..B	VXF47.100	..A
VVF47.125	..B	VXF47.125	..A
VVF47.150	..B	VXF47.150	..A

