



RCU50



RCU50.1



RCU50.2

Room Thermostats

RCU50...

- for CAV / VAV heating and cooling systems
- for AHU systems
- for universal heating and cooling systems

- **Modulating P-control**
- **DC 0...10 V output for heating or cooling**
- **Automatic heating / cooling changeover (RCU50 and RCU50.1)**
- **Manual heating / cooling changeover (RCU50.2)**
- **Operating modes:**
 - Normal operation, energy saving and standby (RCU50 and RCU50.1)
- **Operating modes: normal operation and OFF (RCU50.2)**
- **Operating mode selector (RCU50.1)**
- **Active DC 0...10 V input for setpoint shifting (RCU50 and RCU50.1)**
- **Operating mode changeover input for remote control (RCU50 and RCU50.1)**
- **Adjustable minimum limitation for cooling output (RCU50 and RCU50.1)**
- **Operating voltage AC 24 V**

Control of the room temperature in individual rooms of ventilation or air conditioning plants that are heated or cooled. The RCU50... are especially suited for use with VAV systems in connection with VAV compact controllers type GLB181.1E / 3 and GDB181.1E / 3.

The devices can also be used as an AHU temperature controller in connection with valve actuators, as well as for universal heating and cooling applications with DC 0...10 V actuators.

For the control of the following pieces of equipment:

- VAV compact controllers
- Valve actuators
- Air damper actuators

Functions

The room thermostat acquires the room temperature with its integrated sensor and maintains the setpoint by delivering DC 0...10 V control commands. The RCU50... provides P-control. With the RCU50 and RCU50.1, the proportional band can be 1 or 4 Kelvin in heating mode and 0.5 or 2 Kelvin in cooling mode (selectable with DIP switch no. 4). With the RCU50.2, the proportional band is fixed, 4 Kelvin in heating mode and 2 Kelvin in cooling mode.

**Function diagram
“Heating-cooling“
with min. limitation
cooling**
RCU50 and RCU50.1

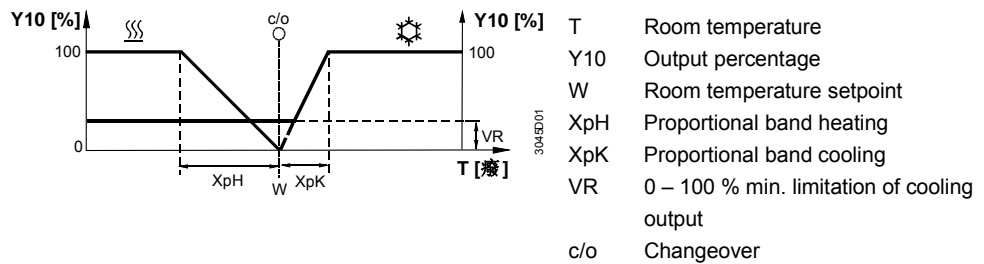

**Function diagram
“Heating-cooling“**
RCU50.2

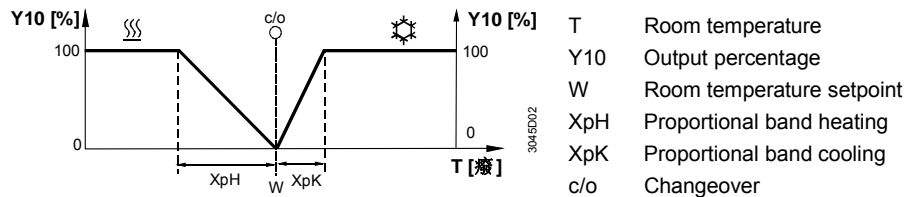

**Minimum limitation of
cooling signal**
(RCU50 and RCU50.1)

Using the potentiometer at the rear of the room thermostat, the cooling signal output can be limited to a minimum value of between 0 and 100 %. This can be used to ensure a minimum supply air volume. When used in connection with a VAV controller, this setting must be taken into account.

**Inversion of output
signal (RCU50.2)**

With the RCU50.2, the output signal can be inverted with the help of DIP switch no. 1. If set to ON, 0 V corresponds to 0 % travel and 10 V to 100 % travel. In position OFF, 0 V corresponds to 100 % travel and 10 V to 0 % travel.

Setpoint shifting
(RCU50 and RCU50.1)

Signal input B1-M is used for outside temperature compensation. Using a DC 0...10 V signal, the setpoint can be shifted by +/- 12.5 Kelvin. The neutral position is at DC 5 V and means no setpoint shift.

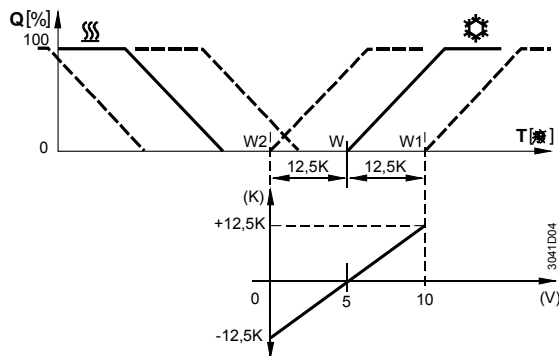

W Original setpoint
W1 Highest setpoint at 10 V input
W2 Lowest setpoint at 0 V input
(K) Setpoint shift
(V) Input voltage



The setpoint shift is limited within the range of the unit of 8 °C (frost protection) to 30 °C.

Automatic changeover (RCU50 and RCU50.1)

The water temperature acquired by the changeover sensor (QAH11.1 + ARG86.3) is used by the room thermostat to switch from heating to cooling mode, or vice versa. When the water temperature lies above 28 °C, the room thermostat switches to heating mode, below 16 °C it switches to cooling mode.

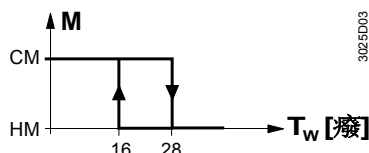

CM Cooling mode
HM Heating mode
M Operating mode
Tw Water temperature

Energy saver

The room temperature setpoint can be limited in increments of 1 Kelvin by making use of the minimum and maximum limitation facility. Arbitrary setpoint readjustments can thus be prevented.

Operating modes

The following operating modes are available:

Normal operation

Normal operation is activated when the operating mode selector is set to “☀” (RCU 50.1) and the external operating mode changeover switch is not activated. In normal operation, the room thermostat maintains the adjusted setpoint.

Frost protection mode (RCU50 and RCU50.1)

Frost protection mode can be activated either

- by manually switching to standby (⏻) (RCU50.1)
- by activating the external operating mode changeover switch, provided DIP switch no. 1 is set to OFF

If the room temperature falls below 8 °C, the room thermostat will automatically switch to frost protection mode. In that case, the heating valve opens and the room temperature is maintained at a setpoint of 8 °C. The setpoint adjusted by the user will be ignored.

Energy saving mode

Energy saving mode can be activated either

- by manually switching to energy saving mode “☾” (RCU50.1)
- by activating the external operating mode changeover switch, provided DIP switch no. 1 is set to ON

In energy saving mode, the setpoint of heating is 16 °C and the setpoint of cooling 28 °C, independent of the position of the setpoint knob.

Operating mode changeover switch (RCU50 and RCU50.1)

A changeover switch can be connected to status input D1–GND. When the switch closes its contact (caused by an open window, for instance), the operating mode will change from normal operation or standby to energy saving mode (provided DIP switch no. 1 is set to ON), or from normal operation or energy saving mode to standby (provided DIP switch no. 1 is set to OFF).

The operating action of the switch (N.C. or N.O.) can be selected.

Type summary

Type reference	Features
RCU50 ^{*)}	Without operating mode selector
RCU50.1 ^{*)}	With operating mode selector
RCU50.2	With manual heating / cooling changeover switch

*) Type is not orderable any more

Ordering

When ordering, please give name and type reference, e.g. room thermostat RCU50. Temperature sensor, changeover mounting kit, VAV compact controller and valve and damper actuators are to be ordered as separate items.

Equipment combinations

Type of unit	Type reference	Data sheet ^{*)}
Temperature sensor	QAH11.1	1840
Changeover mounting kit	ARG86.3	1840
VAV compact controller	GDB181.1E/3 GLB181.1E/3	3544
Motoric actuator (radiator valve)	SSA61...	4893
Motoric actuator (small valve 2,5 mm)	SSP61...	4864
Motoric actuator (small valve 5,5 mm)	SSB61...	4891
Motoric actuator (valve 5,5 mm)	SSC61...	4895
Motoric actuator (valve 5,5 mm)	SQS65...	4573
Air damper / ball valve actuator	GDB161...	4634
	GLB161...	4634
	GCA161.1E	4613
	GBB161...	4626
	GIB161.1E	4626

Mechanical design

The unit consists of two parts:

- A plastic housing which accommodates the electronics, the operating elements and the built-in room temperature sensor
- A mounting base

The housing engages in the mounting base and snaps on.

The base carries the screw terminals. The DIP switches and the potentiometer are located at the rear of the unit.

Operating and setting elements

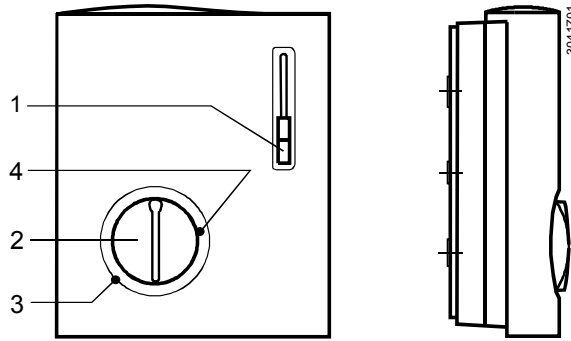

- Legend
- 1 Operating mode selector (RCU50.1)
(normal operation, energy saving mode and standby)
Switch for manual heating / cooling changeover (RCU50.2)
(heating mode, OFF, cooling mode)
 - 2 Room temperature setpoint knob
 - 3 Setting facility for minimum setpoint limitation (in increments of 1 Kelvin)
 - 4 Setting facility for maximum setpoint limitation (in increments of 1 Kelvin)

Set of DIP switches of RCU50 and RCU50.1

DIP switch no.	Meaning	Position ON	Position OFF
1	Operating mode changeover via external switch	Changeover from normal operation or standby to energy saving mode	Changeover from normal operation or energy saving to standby ¹⁾
2	Operating action of switch for external operating mode changeover	Changeover activated when contact of switch is closed (N.O.) ¹⁾	Changeover activated when contact of switch is open (N.C.)
3	Standby	OFF	Frost protection mode (heating output ON at a setpoint of 8 °C) ¹⁾
4	P-band	1 K in heating mode 0.5 K in cooling mode	4 K in heating mode ¹⁾ 2 K in cooling mode ¹⁾
5	Cooling signal output in energy saving mode	Active	Inactive ¹⁾

1) Factory setting

Set of DIP switches of RCU50.2

DIP switch no.	Meaning	Position ON	Position OFF
1	Signal inversion DC 0...10 V	Output signal DC 0...10 V ¹⁾	Output signal DC 10...0 V

1) Factory setting

Accessories

Description	Type reference
Adapter plate 120 x 120 mm for 4" x 4" conduit boxes	ARG70
Adapter plate 96 x 120 mm for 2" x 4" conduit boxes	ARG70.1
Adapter plate for surface wiring 112x130 mm	ARG70.2

In systems without automatic changeover, the temperature sensor can be replaced by an external switch for manual changeover.

In systems with continuous heating operation, no sensor will be connected to the room thermostat's input.

With continuous cooling operation, the controller input (B2-M) must be bridged.

Check the settings of DIP switches no. 1 through no. 5 and of the potentiometer of the RCU50 / RCU50.1 and of DIP switch no. 1 of the RCU50.2 and change them, if required. If setpoint limitation is required, use the minimum and maximum limitation facility (energy saver).

After applying power, the room thermostat makes a reset, which takes about 3 seconds. Then, it will be ready to operate.

The room thermostat is supplied with Mounting Instructions.

Mounting location: on a wall of the room to be conditioned. Not in niches or bookshelves, not behind curtains, above or near heat sources and not exposed to direct solar radiation. Mounting height is about 1.5 m above the floor. The connecting wires can be run to the room thermostat from a recessed conduit box.

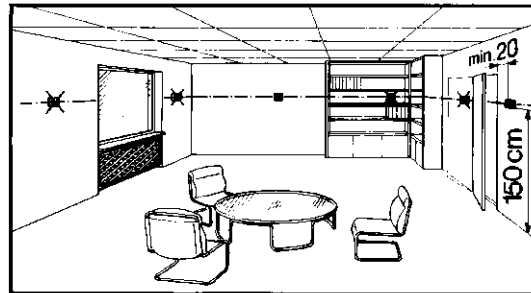

Only authorized personnel may open the room thermostat.

Mounting, installation and commissioning

When mounting the unit, fix the baseplate first. Then, make the electrical connections and fit and secure the cover.

The room thermostat must be mounted on a flat wall and in compliance with local regulations.

If there are thermostatic radiator valves in the reference room, they must be set to their fully open position.



Warning!

No internal line protection for supply lines

Risk of fire and injury due to short-circuits!

- Adapt the line diameters as per local regulations to the rated value of the installed overcurrent protection device.

Maintenance

The room thermostat is maintenance-free.

Disposal



The device is considered an electronic device for disposal in terms of the European Directive 2012/19/EU and may not be disposed of as domestic garbage.

- Dispose of the device through channels provided for this purpose.
- Comply with all local and currently applicable laws and regulations.

Technical data

Power supply	Operating voltage	AC 24 V ± 20 %
	Frequency	50/60 Hz
	Power consumption	max. 6 VA
	No internal fuse	
	External preliminary protection with max. C 10 A circuit breaker in the supply line required under all circumstances	
Functional data	Setpoint setting range	8...30 °C
	Max. control deviation at 25 °C	max. ±0.7 K
	P-band in heating mode	
	RCU50 and RCU50.1 (selectable)	1 K or 4 K
	RCU50.2 (fixed)	4 K
	P-band in cooling mode	
	RCU50 and RCU50.1 (selectable)	0.5 K or 2 K
	RCU50.2 (fixed)	2 K
	Setpoint «Energy saving mode (C)» heating	16 °C
	Setpoint «Energy saving mode (C)» cooling	28 °C
	Setpoint frost protection	8 °C
	Setpoint shift temperature	±12.5 K
	Control output Y10	
	Voltage	DC 0...10 V
	Current	± 1 mA
	Status input D1 and GND (RCU50 / 50.1)	
	Contact sensing	DC 6-15 V / 3-6 mA
Status input B1 (RCU50 / 50.1)		
Setpoint shift of 12.5 K	DC 0...10 V	
Neutral position (no setpoint shift)	DC 5 V	
Changeover- status input B2		
QAH11.1, safety class II NTC resistor 3 kΩ at 25°C		
Max. cable length with copper cable 1.5 mm ²		
For signal input B1 / B2 (RCU50 / 50.1)	80 m	
For signal input D1 (RCU50 / 50.1)	80 m	
Environmental conditions	Operation	
	Climatic conditions	to IEC 60721-3-3 class 3K5
	Temperature	0...+50 °C
	Humidity	<95 % r.h.
	Transport	
	Climatic conditions	to IEC 60721-3-2 class 2K3
	Temperature	-25...+70 °C
	Humidity	<95 % r.h.
	Mechanical conditions	class 2M2
	Storage	
	Climatic conditions	to IEC 60721-3-1 class 1K3
	Temperature	-25...+70 °C
Humidity	<95 % r.h.	

Standards and directives	EU Conformity (CE)	CE1T3040xx ^{*)}
	RCM Conformity	CE1T3040en_C1 ^{*)}
	Degree of protection of housing	IP30 to EN 60 529
	Safety class	III to EN 60 730-1
	Pollution class	normal
Environmental compatibility	The product environmental declaration CE1E3040 ^{*)} contains data on environmentally compatible product design and assessments (RoHS compliance, materials composition, packaging, environmental benefit, disposal).	
General	Connection terminals	Use solid wires or prepared stranded wires. 2 x 0.4-1.5 mm ² or 1 x 2.5 mm ²
	Weight	
	RCU50	0.22 kg
	RCU50.1	0.23 kg
RCU50.2	0.23 kg	
Colour of housing front	white, NCSS0502-G (RAL9003)	

Connection terminals

RCU50 and RCU50.1

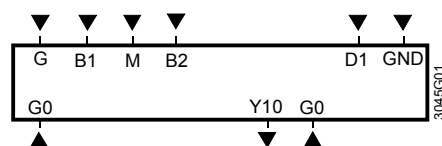

G, G0	Operating voltage AC 24 V
B1	Signal input "Setpoint shift"
B2	Signal input "Changeover sensor"
M	Measuring neutral "Setpoint shift" and "Changeover sensor"
D1,GND	Signal input for potential-free operating mode changeover switch
Y10/G0	Control signal DC 0...10 V

RCU50.2

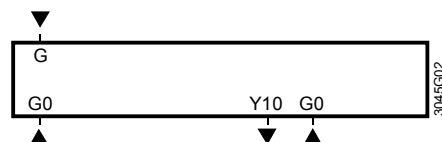

G, G0	Operating voltage AC 24 V
Y10/G0	Control signal DC 0...10 V

Connection diagram

RCU50 and RCU50.1 in VAV/CAV or AHU

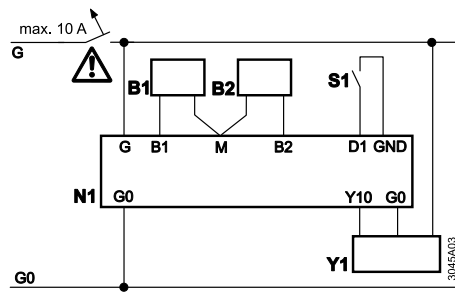

- N1** Room thermostat
- S1** External operating mode changeover switch
- B1** Setpoint shift (outside temperature compensation)
- B2** Changeover sensor for automatic heating/cooling changeover
- Y1** VAV/CAV system, DC 0...10V actuator for heating or cooling

RCU50.2 in VAV/CAV or AHU

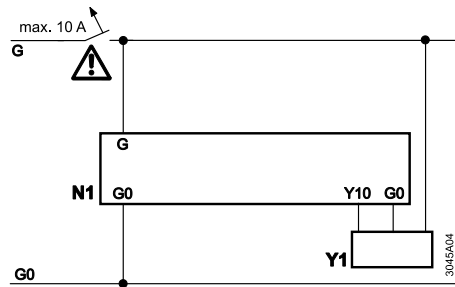

- N1** Room thermostat
- Y1** VAV/CAV system, DC 0...10V actuator for heating or cooling

